

# centor ARCHITECTURAL

E4 bifolding door hardware system for panels to 160kg



centor ARCHITECTURAL  
creating systems for windows & doors

# CONTENTS

Creating Seamless Transitions .....	1
Imagine The Possibilities .....	2
High Performance System .....	3
Proven Durability .....	4
E4 Up Close .....	5
E4 Assurance .....	6
Centor's Bifold Options .....	7
E4 Product Details .....	8
Architectural Detail .....	9
Hardware Selection .....	12
Dropbolts .....	17
Common Panel Layouts .....	21
Surelock II™ Adjustment .....	24



# Creating Seamless Transitions

Centor Architectural's most generously proportioned solution for creating seamless transitions between indoor and outdoor spaces, E4 is heavy-duty bifolding door hardware for panels to 160 Kg. E4 is suitable for openings in larger residential and commercial applications. Taller, wider door panels, expanses of framed glass; E4 provides the flexibility to manage space for lifestyle or business – on a grand scale.

SUITABLE FOR LARGE DOUBLE GLAZED PANELS

16 DOOR PANEL CAPACITY

160 KILOGRAM DOOR PANEL CAPACITY

STAINLESS STEEL CONSTRUCTION

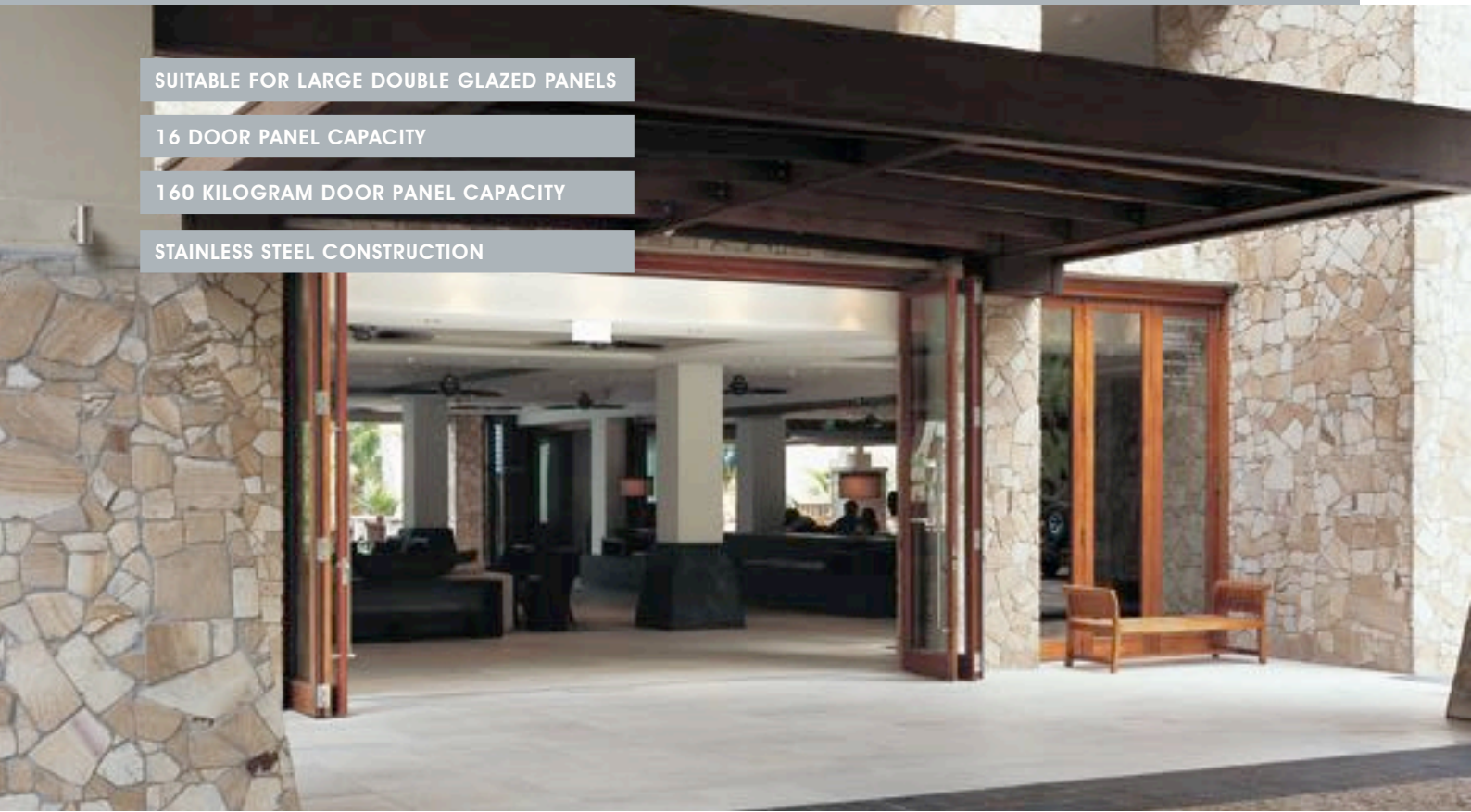

With an impressive panel weight capacity and substantially increased height, width and overall measurement specifications E4 is robust, premium quality hardware which allows an unprecedented level of spatial flexibility. Double glazing and use of the sturdiest materials is possible in previously unimaginable panel sizes, ensuring security and resistance to the elements in the most exposed of applications. The renowned effortless operation of Centor products is maintained, even as maximum panel weight increases, making E4 the perfect way to utilise bifold technology on the largest of projects.

## E4 Specifications

max opening	17.6m
max panel weight	160kg
max panel height	4000mm
max panel width	1300mm
min panel thickness	45mm
max number of panels	16 (8 each direction)

**Note:** Specifications are intended as a guide only. Calculated weight check should be performed to ensure doors built to maximum height and width do not exceed maximum weight.





## Imagine The Possibilities

Business or pleasure, E4 means entertainment without the interruption of conventional sliding or hinged doors, views which become vistas, a breeze when you please! Over the past decade Centor Architectural's groundbreaking exterior bifolding window and door technology has instigated a worldwide revolution in window and door installation.



One moment bifolding doors are acting as an effective, secure barrier from rain, wind and noise. The next they're effortlessly moved aside to reveal wide open space – with no fixed glass panels or posts. E4's massive weight-bearing capacity sets new standards for functional, stylish ways of bringing the outdoors in! Possible applications for Centor's bifold range are limited only by the imaginations of the world's most progressive architects and designers.

Engineered to withstand the most severe weather, E4 is just as suited to interior use where the ability to visually and physically connect spaces can be equally beneficial and the sound-proofing effect of double-glazing just as important. The benefits to the end-user in flexibly managing interior or exterior space to suit lifestyle or business are literally changing the face of contemporary building design.

## CREATING SPACE



## High Performance System

Interior comfort, operational function, durability; painstaking attention to detail and an unerring commitment to quality mean 'Centor-grade' performance, whatever the category. The result is a degree of control and comfort for the end-user that matches the easy flexibility of modern building design.

### INTERIOR COMFORT

E4 is truly a system for all seasons and all locations. Teamed with quality door panels, E4 hardware ensures a formidable barrier against the elements when closed. The integrity of the required interior environment is never compromised.

#### **Rain and Wind**

Centor hardware was utilised in the first tracked bifolding door system to be certified under Australian Standard AS2047, which specifies the weather performance required of external windows and sliding doors. Doors utilising the E4 system have since passed all tests required for product approval from Florida's meticulous Miami-Dade County testing authorities – the single toughest standard of testing anywhere in the world in a region legendary for its coastal hurricanes and seasonal weather. Impressive water performance ratings are achievable from both outward and inward opening doors. Driving rain and howling gales can be shut out completely.

#### **Air Infiltration**

The E4 system achieves its superior rain and wind resistance in part from the way it allows the folding doors to close snugly against weather seals. In the same way doors using E4 effectively resist air infiltration to a level up to 50 times better than a conventional sliding door.

#### **Noise and Temperature**

With double glazing allowed for by E4's impressive panel weight capacity, unprecedented levels of insulation against noise and temperature variation are possible.



A wall of glass that folds away in seconds with E4.

### EFFORTLESS OPERATION

While E4's outstanding performance as part of a secure, weatherproof barrier is crucial, it's not until the doors are opened that the space-transforming benefits of the system truly come into play. For maximum enjoyment and use of the system, every effort has been made to ensure that doors glide open and slide shut with the minimum of effort throughout their working life.

#### **Quality Manufacture, Innovative Design**

E4 carriers, guides and pivots use high grade stainless steel bearings custom machined to extremely fine tolerances on state-of-the-art German and Swiss machinery – a minimum of five bearings to each carrier. Machined wheels are individually precision ground to an ultra-fine hone. Innovative carrier design prevents scraping on the inside of the overhead track.

#### **Assembly and Installation**

Assembly and installation couldn't be easier. Comprehensive instructions are included to ensure precise placement of fittings.

#### **Adjustment**

While E4 is designed to operate flawlessly well into the future, built-in adjustment mechanisms make the system tolerant of an imperfect world. Surelock™, Centor's patented carrier pin locking system ensures that once heights are set they stay set. Should door panels swell or a newly built structure settle over time, the end-user can make vertical and lateral adjustments simply using a screwdriver or Allen key.

### COLLABORATIVE DESIGN PROCESS

E4's thoughtful design doesn't achieve the highest performance in all categories on its own. It's in its element teamed with the quality products created by Centor's many manufacturing and custom fabricating clients. The Centor technical department can assist in the design process for door sets incorporating the E4 system to ensure that the highest criteria for completed and installed doors are met even in the most unusual applications.

## Proven Durability

While Centor Architectural certainly enjoys its reputation for innovation, ensuring that products meet and exceed the highest standards for durability is just as much a passion. This means a significant investment in repeatedly testing systems under the toughest of conditions – then testing them again!



Attention to detail in design, testing and manufacture creates 'Centor-grade' performance.



# CREATING LONGEVITY

### **Laboratory Testing**

In addition to extensive weather testing as part of complete door systems, all individual E4 components have been extensively laboratory tested, ensuring years of trouble-free enjoyment from hardware which ages with grace.

### **Cyclic Testing**

Centor's minimum requirement of cyclic testing for any released product is a grueling 50,000 cycles without a single failure. E4 has been tested in excess of 50,000 cycles.

### **Corrosion Testing**

Stainless steel, brass, aluminum and engineering-grade plastics are used throughout the E4 system and are carefully selected to maximise performance in any environment. Centor conducts regular, thorough corrosion testing in a salt spray chamber, fixing hardware to various substrates to ensure that E4 will perform admirably even in the most exposed of coastal applications.

### **Structural Testing**

As might be expected from a truly heavy-duty system E4's tested strength is exceptional.

In the course of obtaining approval under the stringent Miami-Dade County testing regime, doors based on the E4 system were subjected to hurricane strength wind loads, flexing the doors in and out five thousand times without component failure. Small and large missile impact testing was also performed as part of the single toughest testing process anywhere in the world.

### **Finite Element Analysis**

Finite Element Analysis (FEA) is a computerised simulation technique where products are exposed to virtual operating environments and accurate predictions made in terms of load and deflection. Centor undertakes FEA in the design process to ensure the best balance of performance, cost and materials in every system.



# CREATING DELIGHT

## E4 Up Close

Even a casual glance at the E4 system gives a strong impression of Centor's commitment to quality, but it's only upon closer inspection that the attention to detail really becomes apparent. Behind E4's tough good looks and robust proportions is a system stacked with standard features and flexible options to choose from. It's a system that looks even better up close.

### MATERIALS AND FINISHES

E4 carriers, guides, pivots and hinges are available in brushed stainless steel, or oil rubbed bronze powdercoat (US10B). Support tracks and floor guide channels are produced in extruded aluminium in mill finish, satin, bronze anodised and custom powdercoat. Weatherseals are available in brown, black or white.

### Panel Size and Materials

Centor's innovative hinge system enables the use of uniform-sized door panels regardless of the door configuration ensuring maximum efficiency in door manufacture. Easily installed hardware can be teamed with standard door panels in timber, aluminium, PVC or fibreglass. Maximum panel weight of 120 Kg means panel construction from the sturdiest of materials is possible.

### Design Features

Top-rolling function means superior performance which is never compromised by the issue of debris in tracks. A floating wall pivot is used to control door stile deflection and bowing on tall doors caused by wind loads or climatic conditions. The type of tall, heavy doors typically used with the E4 system will generally require four hinges at each junction.

### Drop Bolts

Easily installed with a dedicated router bit available from Centor, DF and DO dropbolts are available in a range of lengths and finishes to suit every E4 application. Available keyed and non-keyed, the clean-lined DF and DO dropbolts anchor doors firmly in the closed position. Together with the weather seals, they eliminate rattling in strong winds.

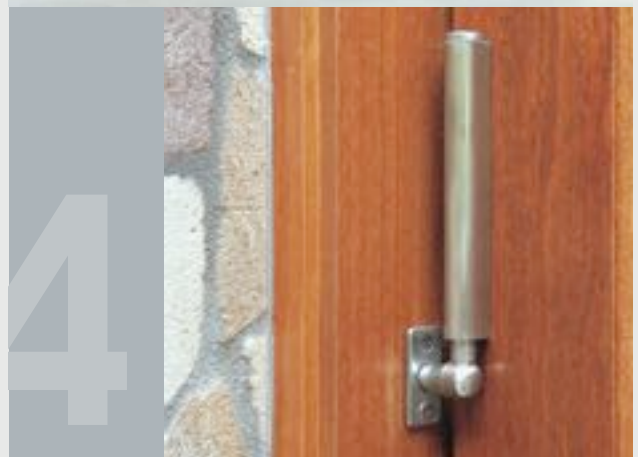
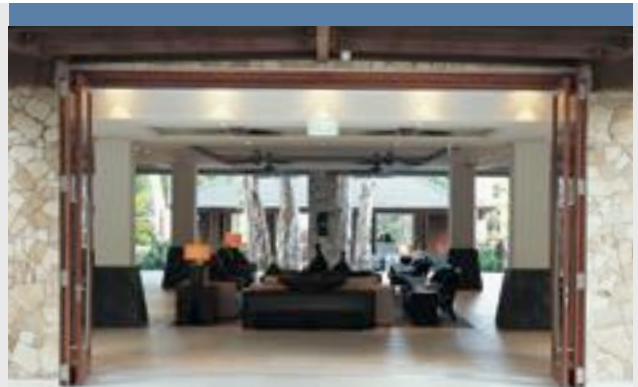

E4 Specifications	
max opening	17.6m
max panel weight	160kg
max panel height	4000mm
max panel width	1300mm
min panel thickness	45mm
max number of panels	16 (8 each direction)

**Note:** Specifications are intended as a guide only. Calculated weight check should be performed to ensure doors built to maximum height and width do not exceed maximum weight.



## E4 Assurance

If success in modern design can be measured by the degree of comfort and ease afforded to the end-user, then Centor E4 again rates highly. E4's superior strength, functioning and performance goes a long way to creating a relaxed setting while a range of other measures allow the system to be utilised with complete confidence.



### Free Specification And Ordering Software

Doorcalc, Centor's free specification and ordering software simplifies component selection and assists with calculating size and number of door panels. Doorcalc can be downloaded from [www.centoreurope.eu](http://www.centoreurope.eu). It features intuitive drop-down menus to assist the inexperienced Excel® user.

# CREATING CONFIDENCE

### UNPARALLELED SECURITY

The E4 system responds to an increasingly security conscious market place with measures designed to ensure unwanted visitors are excluded – as well as the elements.

#### **Concealed Fittings**

When doors utilising E4 are closed there are no externally accessible parts that can be removed or damaged. Screw fixings are concealed and hinge caps are retained by hidden fasteners.

#### **Locking Screw Technology**

The E4 system incorporates locking screw technology which ensures the E4 hardware can not be removed from the track when the doors are closed.

### WARRANTY

In line with a commitment to the highest possible quality Centor offers a 10-year warranty on all E4 hardware.

For full details refer to the current Centor Architectural Catalogue, or view information on line at [www.centoreurope.eu](http://www.centoreurope.eu)

### HARDWARE SELECTION

E4 is a fully integrated system suitable for applications up to 120 Kg per panel in timber, aluminium, PVC or fibreglass. Architects and specifiers should feel comfortable simply specifying 'Centor E4' and leaving detailed component selection to the builder, joiner or fabricator.





# 4 CREATING CHOICE

## Centor's Bifold Options

Based on the same functional geometry but with distinctive capacity and features, Centor's external bifold range offers an alternative for every application. From the smallest folding window to four metre high walls of framed glass panels which fold away in seconds, Centor bifold systems create a formidable barrier against the elements, yet glide open with finger-tip ease.



Developed first and constantly upgraded since their inception EW and E2 remain the perfect choice for the private residence or lighter commercial application. E3 and E4 are Centor's responses to the demands of architects and consumers wishing to expand the potential of bifold innovation into heavier-duty residential and commercial applications. The medium-heavy E3 doubles the panel weight capacity of the E2 system, making even sturdier panel materials and double glazing possible. The heavy-duty E4 system takes it even further. A massive panel weight capacity (120kg) and substantially increased height, width and overall measurement specifications ensures that Centor bifold systems remain the perfect choice for virtually every project.



# E4 Product Details (outward opening configuration shown)

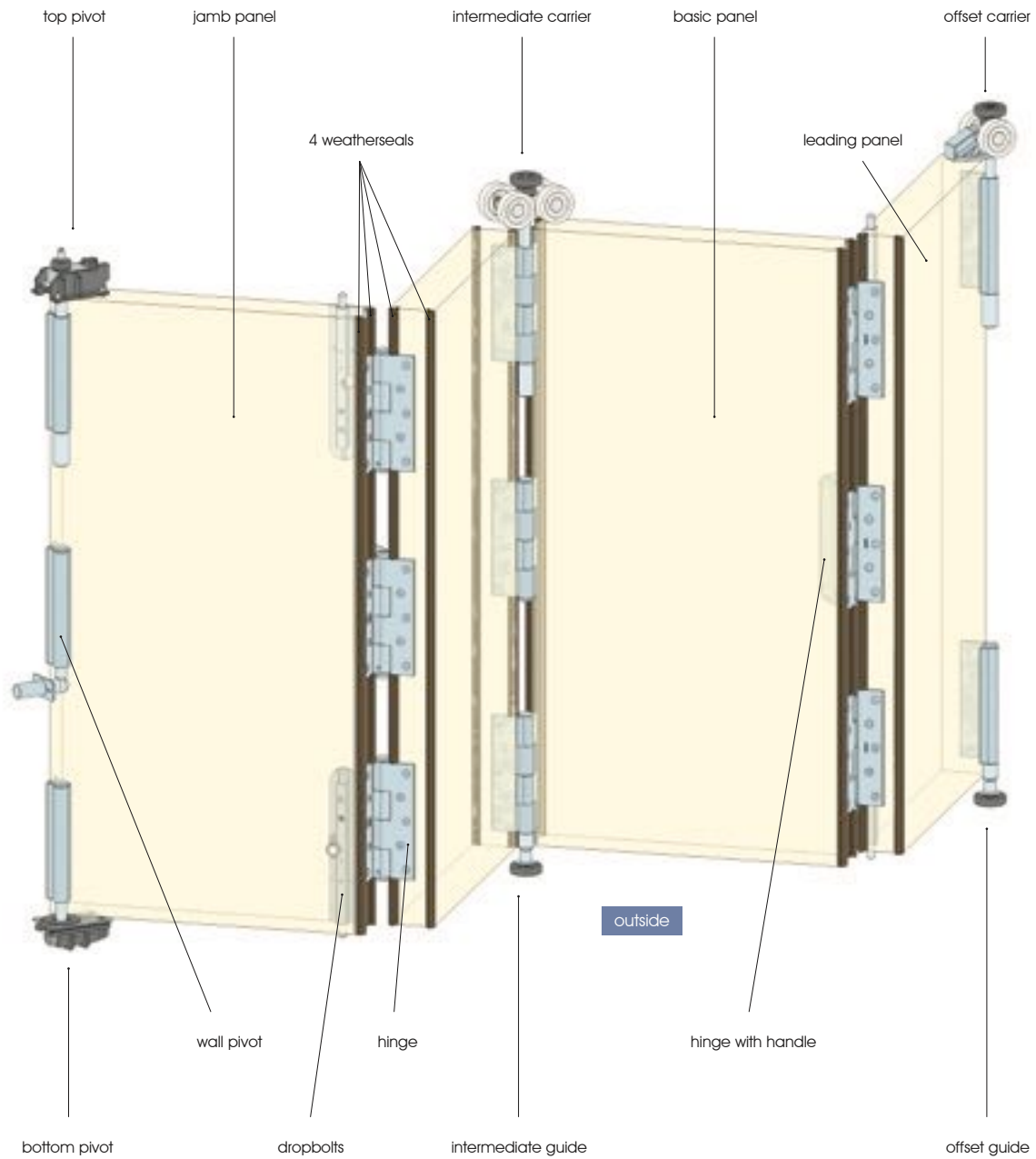

# Architectural Detail

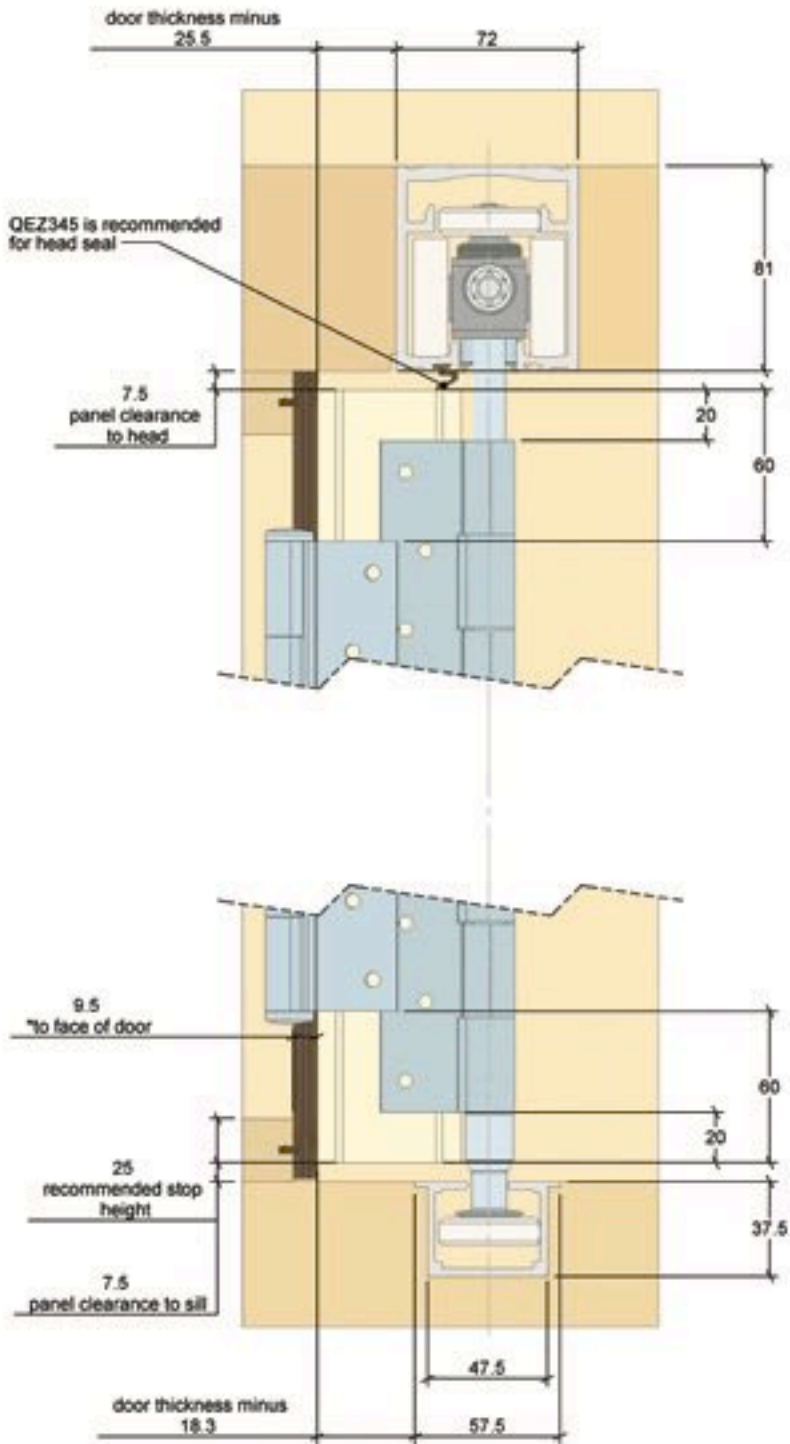

\* recommended seal is E4QLS

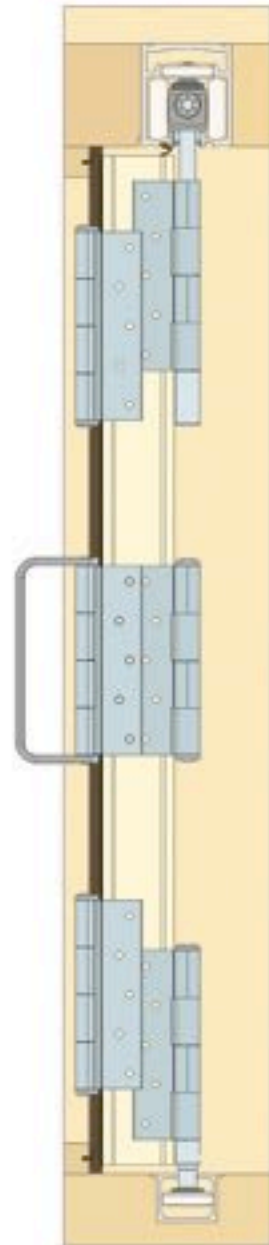

E4-004



# Architectural Detail

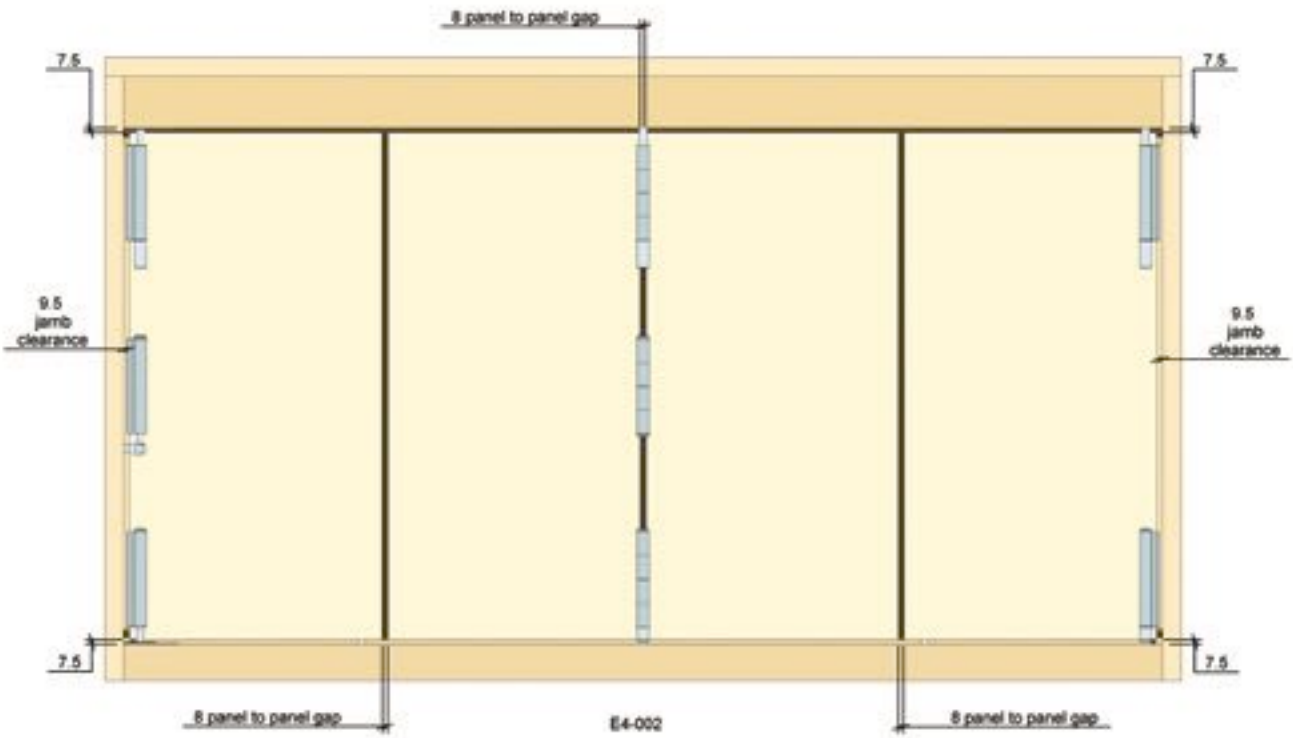
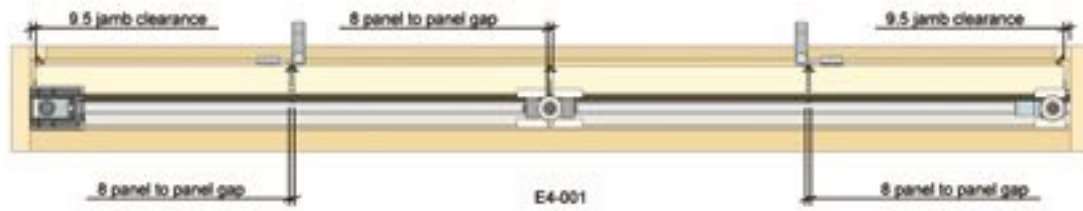

## EQUAL SIZED PANELS

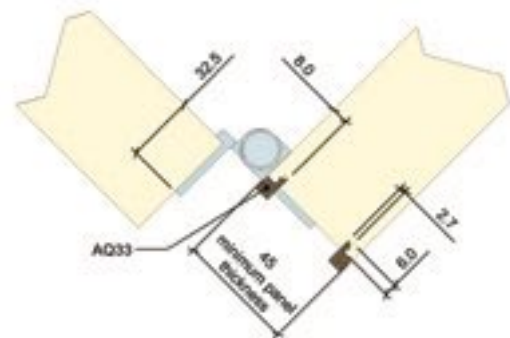
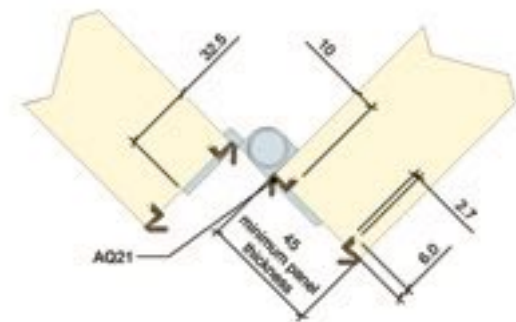
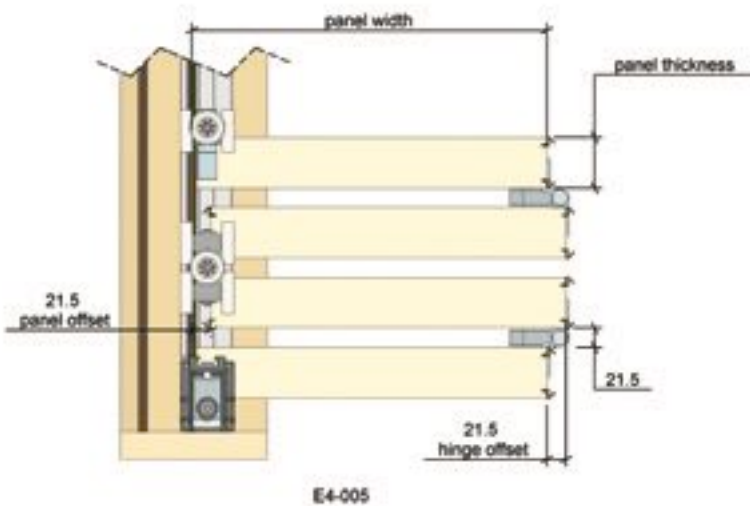

# Architectural Detail

E4 SILL SYSTEM FOR 57.2MM DOOR THICKNESS

E4 HEADER FOR 57.2MM DOOR THICKNESS (TYPICAL)

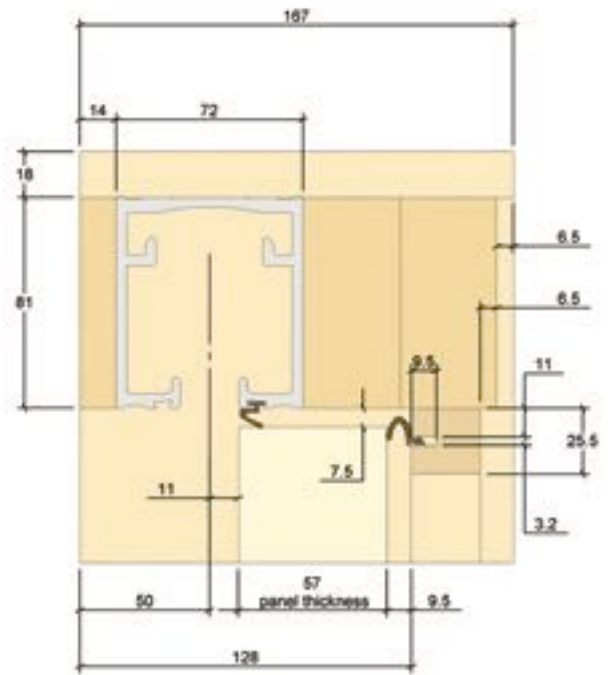
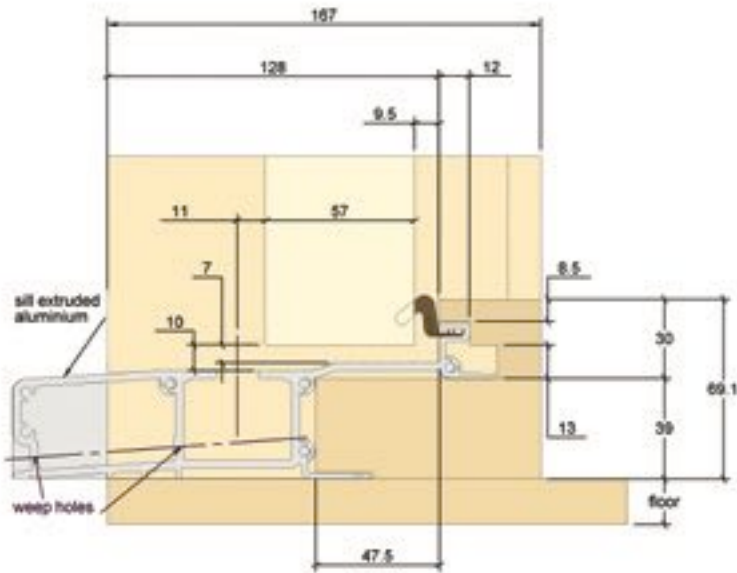

E4-009

E4 JAMB FOR 57.2MM DOOR THICKNESS (TYPICAL)

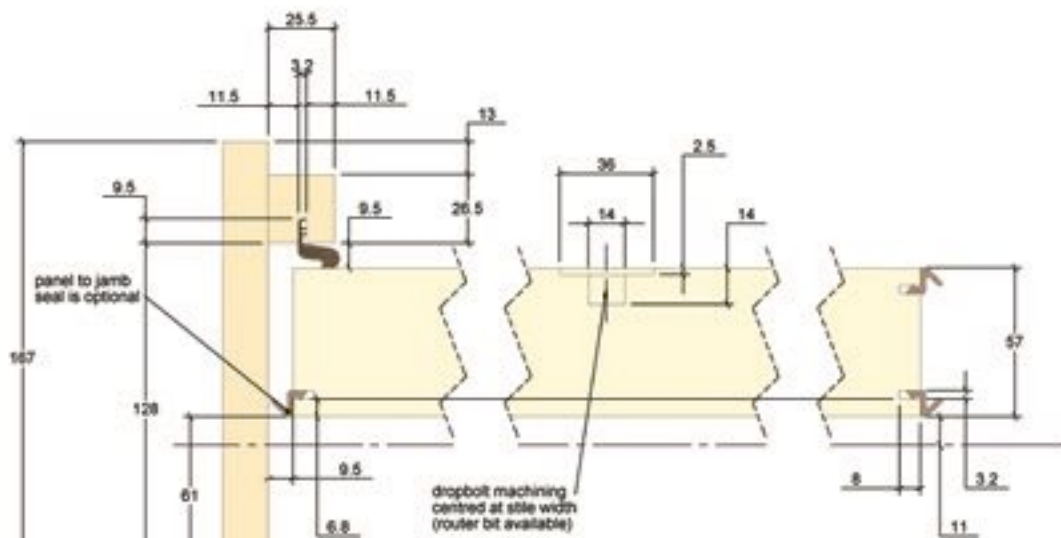

E4-008

## Hardware Selection

E4 is specified with 5 separate groups:

- 1 track
- 2 sill with channel
- 3 hardware
- 4 weathersealing
- 5 dropbolts

Components are required from all 5 groups to build an E4 folding door system.

### TRACK SELECTION

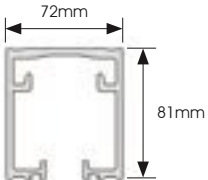
PART	TRACK	PRODUCT CODE	DESCRIPTION
	Aluminium track, machined	E4TM4N	4000mm machined track, natural anodized
		E4TM4R	4000mm machined track, bronze anodized
		E4TM57N	5700mm machined track, natural anodized
		E4TM57R	5700mm machined track, bronze anodized

SILL SYSTEM (SILL LENGTHS UP TO 8.22M. CUT TO LENGTH ON APPLICATION.)

PART	TRACK	PRODUCT CODE	DESCRIPTION
		781E3C	aluminum sill, natural anodized
		781E3D	aluminum sill, bronze anodized



### CHANNEL SELECTION

PART	TRACK	PRODUCT CODE	DESCRIPTION
	Aluminium E4 floor channel pre-machined	E4FCM4N	4000mm machined channel, natural anodized
		E4FCM4R	4000mm machined channel, bronze anodized
		E4FCM57N	5700mm machined channel, natural anodized
		E4FCM57R	5700mm machined channel, bronze anodized





# Hardware Selection

## INTERMEDIATE CARRIER SET

PARTS	PARTS ON PANELS	PRODUCT CODE	DESCRIPTION
		E4ICSQ  E4ICSS	intermediate carrier set, oil rubbed bronze powdercoat  intermediate carrier set, stainless steel

## OFFSET CARRIER SET

PARTS	PARTS ON PANELS	PRODUCT CODE	DESCRIPTION
		E4OCSQ  E4OCSS	offset carrier set, oil rubbed bronze powdercoat  offset carrier set, stainless steel

## Hardware Selection

### PIVOT SET / WALL PIVOT

Wall pivots are mandatory on door panels over 2150mm. Wall pivots are strongly recommended on all door panels in wet or humid climates, exposed locations, inward opening applications and unstable timber doors. A second pivot can be used on door panels over 2250mm to match the additional row of hinges.

PARTS	PARTS ON PANELS	PRODUCT CODE	DESCRIPTION
	a)	E4PSQ	pivot set, oil rubbed bronze powdercoat
	b)	E4PSS	pivot set, stainless steel
	a)	E4WPQ	wall pivot set, oil rubbed bronze powdercoat
	b)	E4WPS	wall pivot set, stainless steel
	b)		
	c)		

a) pivot set

b) pivot set and jamb mounted middle wall pivot mandatory on door panels over 2150mm to prevent/control deflection and bowing



c) pivot set and jamb mounted two middle wall pivots recommended for door panels over 2250mm

### HALF OFFSET HINGE SET



PARTS	PARTS ON PANELS	PRODUCT CODE	DESCRIPTION
		E4HHSQ	half offset hinge set, oil rubbed bronze powdercoat
		E4HHSS	half offset hinge set, stainless steel

## Hardware Selection



### STRAIGHT HINGE SET

PARTS	PARTS ON PANELS	PRODUCT CODE	DESCRIPTION
		E4HSQ E4HSS	hinge set, oil rubbed bronze powdercoat hinge set, stainless steel

### SINGLE HALF OFFSET HINGE (RECOMMENDED FOR DOORS OVER 2250MM)

PARTS	PARTS ON PANELS	PRODUCT CODE	DESCRIPTION
		E4HHNHQ E4HHNHS	hinge, oil rubbed bronze powdercoat hinge, stainless steel



### SINGLE STRAIGHT HINGE (RECOMMENDED FOR DOORS OVER 2250MM)

PARTS	PARTS ON PANELS	PRODUCT CODE	DESCRIPTION
		E4HQ E4HS	hinge, oil rubbed bronze powdercoat hinge, stainless steel





# Hardware Selection

## WEATHERSEALS AND ASTRAGAL SELECTION

PARTS	PRODUCT CODE	DESCRIPTION
	AQ21B	brown weatherseal for between doors
	AQ21L	black weatherseal for between doors
	AQ21W	white weatherseal for between doors
	E4QLSB	brown weatherseal for sill, jamb and header (perimeter)
	E4QLSW	white weatherseal for sill, jamb and header (perimeter)
	QEZ345B	Aquamac 345, head seal, brown
	QEZ345L	Aquamac 345, head seal, black
	QEZ345W	Aquamac 345, head seal, white

## WEATHERSEAL ALTERNATE SELECTION

PART	PRODUCT CODE	PART DESCRIPTION
	AQ33B	Aquamac 33 Schlegel Kerf seal, brown for between doors
	AQ33L	Aquamac 33 Schlegel Kerf seal, black for between doors
	AQ33W	Aquamac 33 Schlegel Kerf seal, white for between doors
	AQ109B	Aquamac 109 Schlegel Kerf seal, brown for access panel and astragal
	AQ109L	Aquamac 109 Schlegel Kerf seal, black for access panel and astragal
	AQ109W	Aquamac 109 Schlegel Kerf seal, white for access panel and astragal

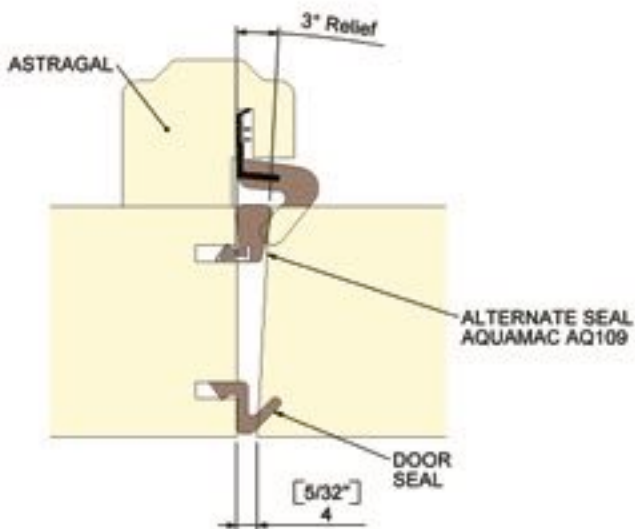

## Dropbolts

Centor's stylish, flush-mounting dropbolts have been specifically designed for use with Centor systems and to meet the unique security and weatherproofing conditions that exist with bifolding doors. Easily installed with a dedicated router bit available from Centor, DF and DO dropbolts are available in a range of lengths and finishes to suit every application. Available keyed and non-keyed, DF and DO dropbolts are keyed alike or can be re-keyed.



### CENTOR DF

Rated to resist the most extreme wind conditions (up to 450kg in certain timbers) DF dropbolts feature rounded styling and are suited to use with outward opening bifold doors. Available in 200mm, 400mm, 600mm and 1000mm lengths with a 20mm throw they come in gold anodised, brushed metallic and custom powdercoated finishes. Keyed DF dropbolts feature a unique bifold damage-proofing mechanism which prevents the bolt being operated while the key remains in the lock.



### CENTOR DO

Offering all the style, security and choice of DF, DO dropbolts suit inward opening doors based on the E4 system.



# Dropbolts

## DF / KEYED

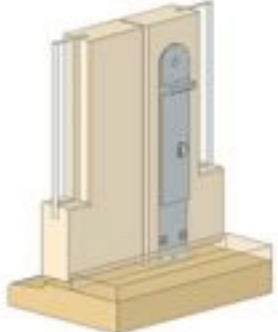
PARTS	ARCHITECTURAL DETAIL	PRODUCT CODE	DESCRIPTION
		DBFO200KRG	200mm dropbolt, keyed, gold anodised
		DBFO200KRX	200mm dropbolt, keyed, brushed metallic
		DBFO400KRG	400mm dropbolt, keyed, gold anodised
		DBFO400KRX	400mm dropbolt, keyed, brushed metallic
		DBFO600KRG	600mm dropbolt, keyed, gold anodised
		DBFO600KRX	600mm dropbolt, keyed, brushed metallic
		DBFO1000KRX	1000mm dropbolt, keyed, brushed metallic

Chrome, gold anodised, natural anodised and custom powdercoat available by special order.

## DF / NON-KEYED

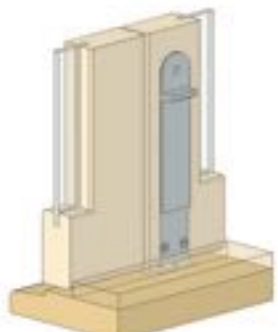
PARTS	ARCHITECTURAL DETAIL	PRODUCT CODE	DESCRIPTION
		DBFO200NRG	200mm dropbolt, non-keyed, gold anodised
		DBFO200NRX	200mm dropbolt, non-keyed, brushed metallic
		DBFO400NRG	400mm dropbolt, non-keyed, gold anodised
		DBFO400NRX	400mm dropbolt, non-keyed, brushed metallic
		DBFO600NRG	600mm dropbolt, non-keyed, gold anodised
		DBFO600NRX	600mm dropbolt, non-keyed, brushed metallic
		DBFO1000NRX	1000mm dropbolt, non-keyed, brushed metallic

Chrome, gold anodised, natural anodised and custom powdercoat available by special order.



# Dropbolts

## DY / KEYED

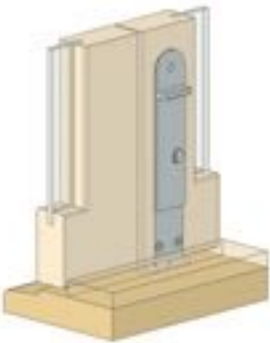
PARTS	ARCHITECTURAL DETAIL	PRODUCT CODE	DESCRIPTION
		DBSY200KRG	200mm dropbolt, keyed, gold anodised
		DBSY200KRQ	200mm dropbolt, keyed, oil rubbed bronze powdercoat
		DBSY200KRX	200mm dropbolt, keyed, brushed metallic
		DBSY400KRQ	400mm dropbolt, keyed, oil rubbed bronze powdercoat
		DBSY600KRQ	600mm dropbolt, keyed, oil rubbed bronze powdercoat

Chrome, gold anodised, natural anodised and custom powdercoat available by special order.

## DY / NON-KEYED

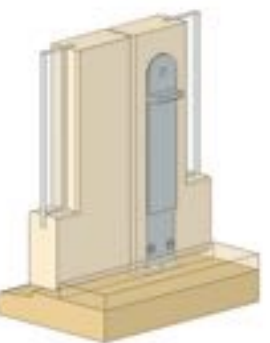
PARTS	ARCHITECTURAL DETAIL	PRODUCT CODE	DESCRIPTION
		DBSY200NRG	200mm dropbolt, non-keyed, gold anodised
		DBSY200NRQ	200mm dropbolt, non-keyed, oil rubbed bronze powdercoat
		DBSY200NRX	200mm dropbolt, non-keyed, brushed metallic
		DBSY400NRG	400mm dropbolt, non-keyed, gold anodised
		DBSY400NRQ	200mm dropbolt, non-keyed, oil rubbed bronze powdercoat
		DBSY400NRX	400mm dropbolt, non-keyed, brushed metallic
		DBSY600NRG	600mm dropbolt, non-keyed, gold anodised
		DBSY600NRQ	600mm dropbolt, non-keyed, oil rubbed bronze powdercoat
		DBSY1000NRQ	1000mm dropbolt, non-keyed, oil rubbed bronze powdercoat

Chrome, gold anodised, natural anodised and custom powdercoat available by special order.

## Dropbolts (for inward opening doors)

### DO / KEYED

PARTS	PRODUCT CODE	DESCRIPTION
	DBOE200KRG	200mm, keyed, gold anodised
	DBOE200KRQ	200mm, keyed, oil rubbed bronze powdercoat
	DBOE200KRX	200mm, keyed, brushed metallic
	DBOE400KRG	200mm, keyed, gold anodised
	DBOE400KRX	200mm, keyed, brushed metallic
	DBOE600KRG	200mm, keyed, gold anodised
	DBOE600KRX	200mm dropbolt, keyed, brushed metallic

### DO / NON-KEYED

PARTS	PRODUCT CODE	DESCRIPTION
	DBOE200NRG	200mm, non-keyed, gold anodised
	DBOE200NRQ	200mm, non-keyed, oil rubbed bronze powdercoat
	DBOE200NRX	200mm, non-keyed, brushed metallic
	DBOE400NRG	200mm, non-keyed, gold anodised
	DBOE400NRQ	200mm, non-keyed, oil rubbed bronze powdercoat
	DBOE400NRX	200mm, non-keyed, brushed metallic
	DBOE600NRG	200mm, non-keyed, gold anodised
	DBOE600NRQ	200mm, non-keyed, oil rubbed bronze powdercoat
	DBOE600NRX	200mm, non-keyed, brushed metallic
	DBOE1000NRG	200mm, non-keyed, gold anodised
	DBOE1000NRQ	200mm, non-keyed, oil rubbed bronze powdercoat
	DBOE1000NRX	200mm, non-keyed, brushed metallic

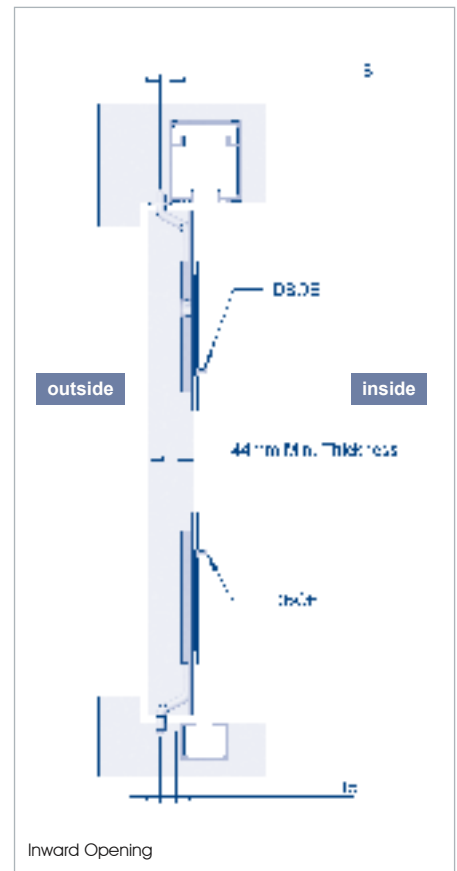

### ROUTER BIT

PART	PRODUCT CODE	DESCRIPTION
	DBFORB	dedicated router bit for professional installation of Centor Architectural DH, DF, DL, DY and DO dropbolts

### CUPS

PART	PRODUCT CODE	DESCRIPTION
	DBCS	dropbolt cup, stainless steel
	DBCQ	dropbolt cup, oil rubbed bronze powdercoat
	DBCB	dropbolt cup, brass

# Common Panel Layouts

HARDWARE LEGEND	
PS	pivot set
WPS	wall pivot set
ICS	intermediate carrier set
OCS	offset carrier set (reversible)
HHS	half offset hinge set
HS	hinge set (flat)
DB	dropbolt

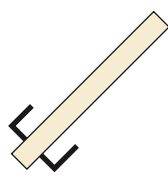
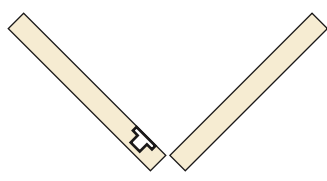
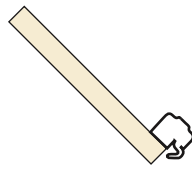
LEGEND	
Passage set / Lock by other	
Dropbolts top and bottom	
Astragal	

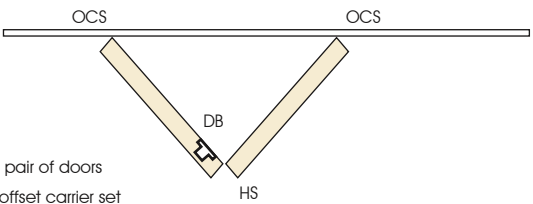
FLOATING DOOR PAIRS	
	<p>Per pair of doors</p> <ul style="list-style-type: none"> <li>2x offset carrier set</li> <li>1 x hinge set</li> <li>2 x dropbolt</li> </ul>

HARDWARE APPLICATION (3L2R)	
<p>ICS Intermediate Carrier and Guide Set</p> <p>Basic Door</p> <p>PS Pivot Set</p> <p>Jamb Door</p> <p>DB Dropbolt</p> <p>HHS Half Offset Hinge Set</p>	<p>Leading Door</p> <p>Service Door</p> <p>Passage Set / Lock By Other</p> <p>HS Flat Hinge Set</p> <p>OCS Offset Carrier and Guide Set</p> <p>PS Pivot Set</p> <p>Jamb Door</p> <p>DB Dropbolt</p>

# Common Panel Layouts (outward)

CODE	OPENING CONFIGURATION	HARDWARE
2L	inside WPS, PS not accessible from exterior outside	1 x pivot set 1 x wall pivot set 1 x offset carrier set 1 x hinge set 2 x dropbolt
2L1R	inside WPS, PS outside	2 x pivot set 2 x wall pivot set 1 x offset carrier set 1 x hinge set 2 x dropbolt
3L	inside WPS, PS ICS outside	1 x pivot set 1 x wall pivot set 1 x intermediate carrier set 1 x half offset hinge set 2 x dropbolt
3L1R	inside WPS, PS ICS WPS, PS outside	2 x pivot set 2 x wall pivot set 1 x intermediate carrier set 1 x half offset hinge set 4 x dropbolt
4L	inside WPS, PS ICS OCS not accessible from exterior outside	1 x pivot set 1 x wall pivot set 1 x intermediate carrier set 1 x offset carrier set 2 x half offset hinge set 4 x dropbolt
4L1R	inside WPS, PS ICS WPS, PS outside	2 x pivot set 2 x wall pivot set 1 x intermediate carrier set 1 x offset carrier set 2 x half offset hinge set 4 x dropbolt
3L2R	inside WPS, PS ICS WPS, PS outside	2 x pivot set 2 x wall pivot set 1 x intermediate carrier set 1 x offset carrier set 1 x hinge set 1 x half offset hinge set 4 x dropbolt
5L	inside WPS, PS ICS ICS outside	1 x pivot set 1 x wall pivot set 2 x intermediate carrier set 1 x hinge set 1 x half offset hinge set 4 x dropbolt
3L3R	inside WPS, PS ICS ICS WPS, PS outside	2 x pivot set 2 x wall pivot set 2 x intermediate carrier set 2 x half offset hinge set 6 x dropbolt
7L	inside WPS, PS ICS ICS ICS outside	1 x pivot set 1 x wall pivot set 3 x intermediate carrier set 2 x hinge set 1 x half offset hinge set 6 x dropbolt
4L3R	inside WPS, PS ICS OCS ICS WPS, PS outside	2 x pivot set 2 x wall pivot set 2 x intermediate carrier set 1 x offset carrier set 3 x half offset hinge set 6 x dropbolt
5L2R	inside WPS, PS ICS ICS OCS WPS, PS outside	2 x pivot set 2 x wall pivot set 2 x intermediate carrier set 1 x offset carrier set 2 x hinge set 1 x half offset hinge set 6 x dropbolt
5L3R	inside WPS, PS ICS ICS ICS WPS, PS outside	2 x pivot set 2 x wall pivot set 3 x intermediate carrier set 1 x hinge set 2 x half offset hinge set 8 x dropbolt



CODE	OPENING CONFIGURATION	HARDWARE
2R	<p>inside PS, WPS not accessible from exterior</p> <p>outside OCS HS</p>	<ul style="list-style-type: none"> <li>1 x pivot set</li> <li>1 x wall pivot set</li> <li>1 x offset carrier set</li> <li>1 x hinge set</li> <li>2 x dropbolt</li> </ul>
1L2R	<p>inside WPS, PS WPS, PS</p> <p>outside OCS HS</p>	<ul style="list-style-type: none"> <li>2 x pivot set</li> <li>2 x wall pivot set</li> <li>1 x offset carrier set</li> <li>1 x hinge set</li> <li>2 x dropbolt</li> </ul>
3R	<p>inside ICS WPS, PS</p> <p>outside HHS</p>	<ul style="list-style-type: none"> <li>1 x pivot set</li> <li>1 x wall pivot set</li> <li>1 x intermediate carrier set</li> <li>1 x half offset hinge set</li> <li>2 x dropbolt</li> </ul>
1L3R	<p>inside WPS, PS ICS WPS, PS</p> <p>outside HHS</p>	<ul style="list-style-type: none"> <li>2 x pivot set</li> <li>2 x wall pivot set</li> <li>1 x intermediate carrier set</li> <li>1 x half offset hinge set</li> <li>4 x dropbolt</li> </ul>
2L2R	<p>inside WPS, PS OCS OCS WPS, PS not accessible from exterior</p> <p>outside HS HS</p>	<ul style="list-style-type: none"> <li>2 x pivot set</li> <li>2 x wall pivot set</li> <li>2 x offset carrier set</li> <li>2 x hinge set</li> <li>4 x dropbolt</li> </ul>
1L4R	<p>inside WPS, PS OCS ICS WPS, PS</p> <p>outside HHS HHS</p>	<ul style="list-style-type: none"> <li>2 x pivot set</li> <li>2 x wall pivot set</li> <li>1 x intermediate carrier set</li> <li>1 x offset carrier set</li> <li>2 x half offset hinge set</li> <li>4 x dropbolt</li> </ul>
4R	<p>inside OCS ICS WPS, PS not accessible from exterior</p> <p>outside HHS HHS</p>	<ul style="list-style-type: none"> <li>1 x pivot set</li> <li>1 x wall pivot set</li> <li>1 x intermediate carrier set</li> <li>1 x offset carrier set</li> <li>2 x half offset hinge set</li> <li>4 x dropbolt</li> </ul>
2L3R	<p>inside WPS, PS OCS ICS WPS, PS</p> <p>outside HS HHS</p>	<ul style="list-style-type: none"> <li>2 x pivot set</li> <li>2 x wall pivot set</li> <li>1 x intermediate carrier set</li> <li>1 x offset carrier set</li> <li>1 x hinge set</li> <li>1 x half offset hinge set</li> <li>4 x dropbolt</li> </ul>
5R	<p>inside ICS ICS WPS, PS</p> <p>outside HS HHS</p>	<ul style="list-style-type: none"> <li>1 x pivot set</li> <li>1 x wall pivot set</li> <li>2 x intermediate carrier set</li> <li>1 x hinge set</li> <li>1 x half offset hinge set</li> <li>4 x dropbolt</li> </ul>
3L4R	<p>inside WPS, PS ICS OCS ICS WPS, PS</p> <p>outside HHS HHS HHS</p>	<ul style="list-style-type: none"> <li>2 x pivot set</li> <li>2 x wall pivot set</li> <li>2 x intermediate carrier set</li> <li>1 x offset carrier set</li> <li>3 x half offset hinge set</li> <li>6 x dropbolt</li> </ul>
7R	<p>inside ICS ICS ICS WPS, PS</p> <p>outside HS HS HHS</p>	<ul style="list-style-type: none"> <li>1 x pivot set</li> <li>1 x wall pivot set</li> <li>3 x intermediate carrier set</li> <li>2 x hinge set</li> <li>1 x half offset hinge set</li> <li>6 x dropbolt</li> </ul>
2L5R	<p>inside WPS, PS OCS ICS ICS WPS, PS</p> <p>outside HS HS HHS</p>	<ul style="list-style-type: none"> <li>2 x pivot set</li> <li>2 x wall pivot set</li> <li>2 x intermediate carrier set</li> <li>1 x offset carrier set</li> <li>2 x hinge set</li> <li>1 x half offset hinge set</li> <li>6 x dropbolt</li> </ul>
8R	<p>inside OCS ICS ICS ICS WPS, PS not accessible from exterior</p> <p>outside HHS HS HS HHS</p>	<ul style="list-style-type: none"> <li>1 x pivot set</li> <li>1 x wall pivot set</li> <li>3 x intermediate carrier set</li> <li>1 x offset carrier set</li> <li>2 x hinge set</li> <li>2 x half offset hinge set</li> <li>8 x dropbolt</li> </ul>

# CREATING FLEXIBILITY

## Surelock II™ Adjustment

E4 hardware has been designed for large, heavy doors which inevitably will also be tall. The ability to conveniently adjust and set the heights of such door panels has been given careful consideration. The Sure-Lock II™ allows easy adjustment with the Allen Key provided.

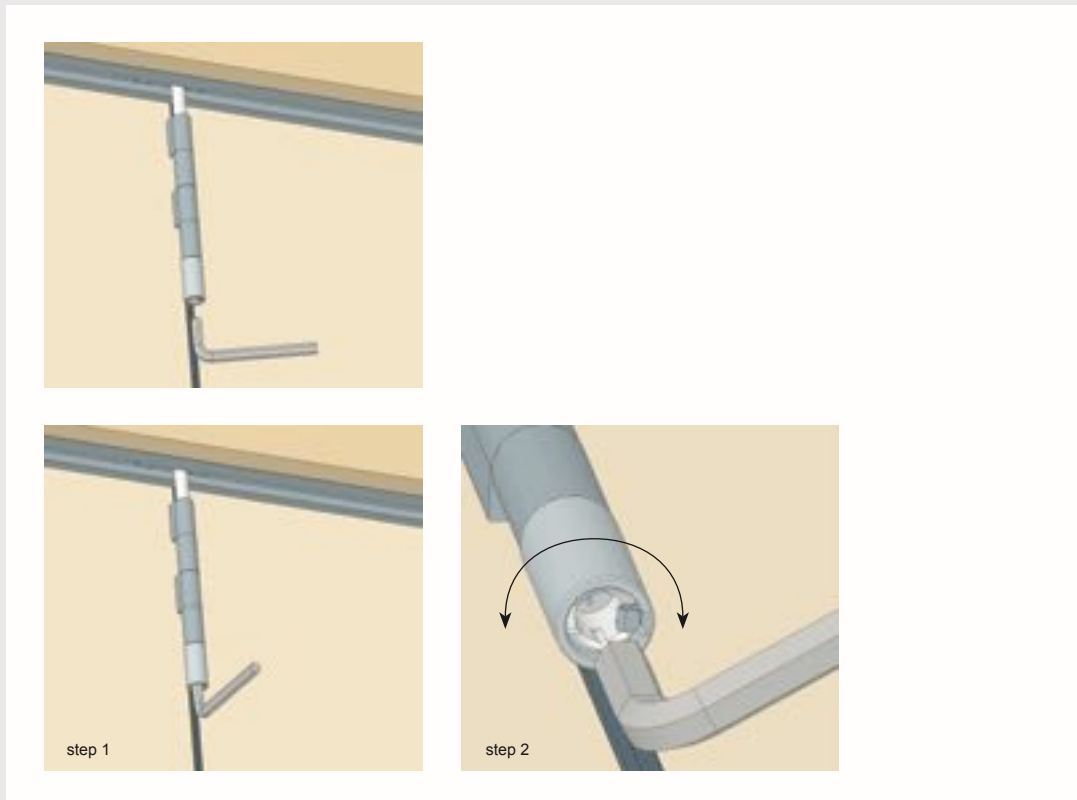

This stainless steel Surelock II™ mechanism has three significant features:

- Adjusting the height setting requires only a single tool, a 9.5mm / (3/8") Hexagon Allen Key, in a single-handed operation. There is no need to hold or steady the Surelock II™ while the adjustment is being made. An Allen Key is provided with E4 pivot sets.
- Insertion of the key disengages the self-locking spring latch. Once adjusted, the new setting is locked into place simply by allowing the latch to fall back into the locating slot as the key is removed.
- A retaining screw limits the travel of the Sure-Lock II™ so that it cannot be adjusted to a structurally unsafe position.

## E2

E2 is a medium bifolding door hardware system for panels to 40 Kg. E2 is suitable for a range of residential and light commercial applications which do not require the extra capacity of the medium-heavy E3 or the substantial E4 heavy-duty door system. Easily installed E2 hardware can be teamed with standard door panels in timber, aluminium, PVC or fibreglass.



## E3

Centor E3 is a medium-heavy bifolding door hardware system for door panels to 80 Kg. E3 is suitable for a range of applications from stylish private residences to the most ambitious store front, restaurant or commercial project; anywhere the ability to flexibly manage space to suit lifestyle or business is required. Easily installed E3 hardware can be teamed with standard door panels in timber, aluminium, PVC or fibreglass.



## DROPBOLTS

Centor's stylish keyed and non-keyed, flush-mounting dropbolts are the ideal solution for securing or fastening in place closed folding or sliding windows and doors. Produced to Centor's exacting standards for functionality, aesthetics and longevity, seven distinctive dropbolt ranges are available in lengths, styles and finishes to suit virtually any application.

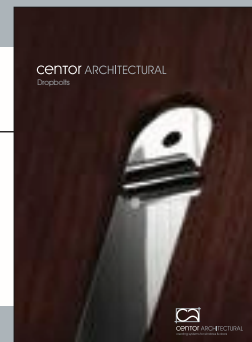

## ES2

Centor's door screening system for bifold doors is integrated into the bifolding door frame itself. This new system, a superbly effective, world-first fully integrated screening solution for openings as large as 3m high and 5.8m wide, means there's no need to compromise between uninterrupted views and unrestricted movement in the summer months and the need to eliminate annoying flying pests year-round.





204.300.030.001

Centor Europe Ltd

610 Solar Park  
Highlands Road  
Solihull, B90 4SH, UK  
telephone +44 (0)121 701 2500  
facsimile +44 (0)121 701 2515  
mail@centor.eu  
www.centor.eu



**centor** ARCHITECTURAL  
creating systems for windows & doors